

## ON/OFF

### DESCRIPTION OF BUTTONS

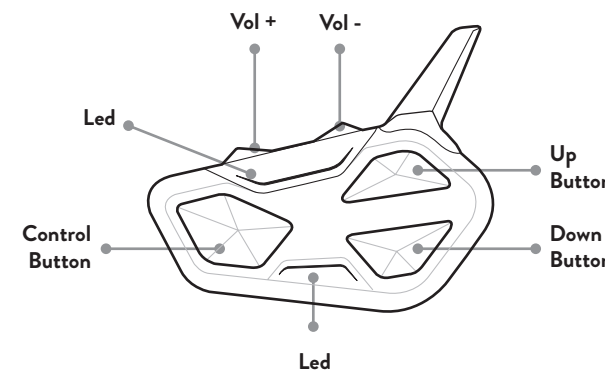

### SWITCH ON

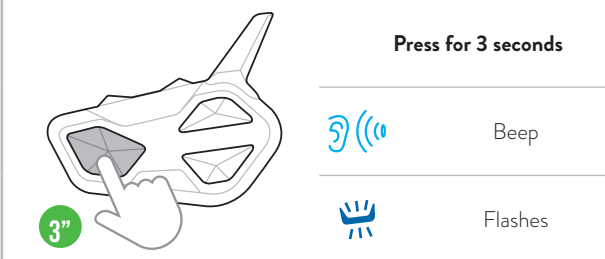

### SWITCH OFF

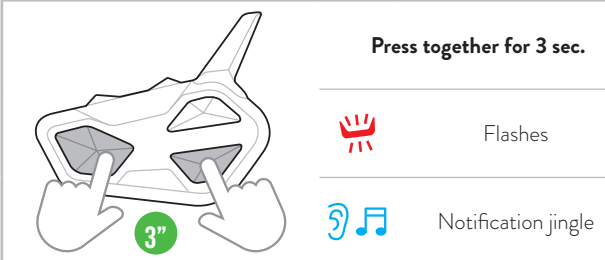

## PAIRINGS

### DESCRIPTION OF BUTTONS

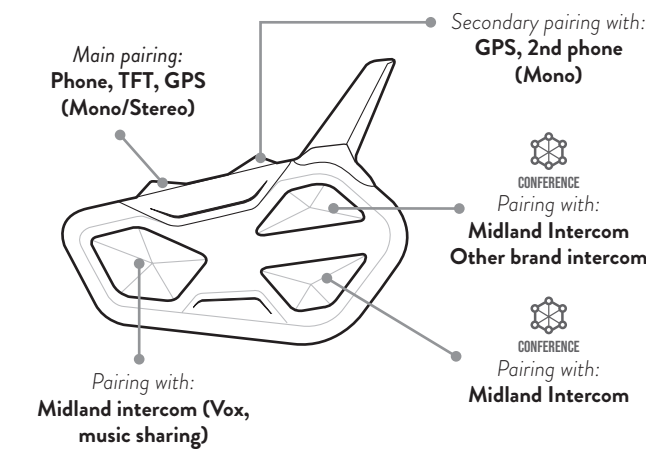

**ATTENTION:** To carry out any pairings you need to access Settings. If the Control button is pressed for fewer than 7 seconds, the device will switch itself on instead of accessing Settings. If this occurs, repeat the process.

### ACCESS SETTINGS

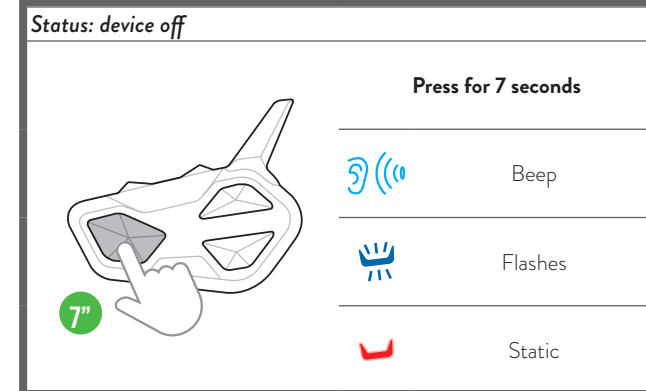

### PHONE, GPS, TFT PAIRING

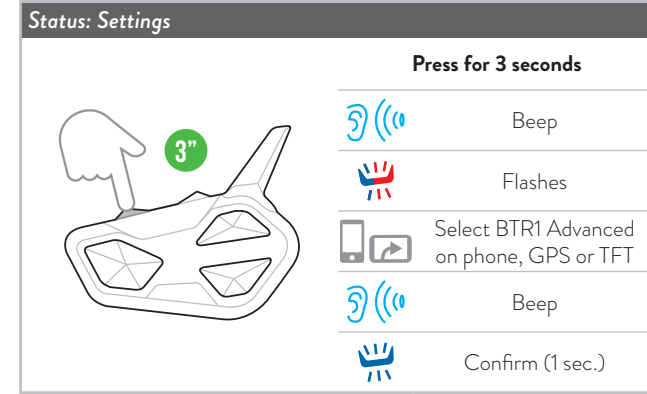

**Note:** to pair a 2nd device in mono audio, repeat this procedure using Vol -.

### MIDLAND INTERCOM PAIRING

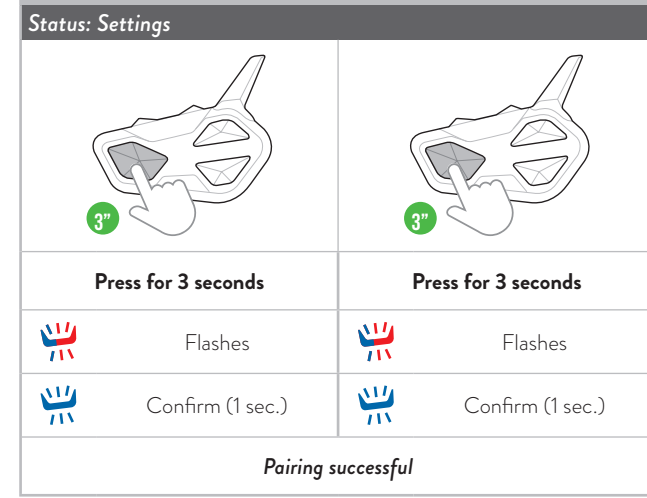

**Note:** to pair another Midland intercom, follow the same procedure using the Up/Down buttons.

### OTHER BRAND INTERCOM PAIRING (UNIVERSAL INTERCOM)

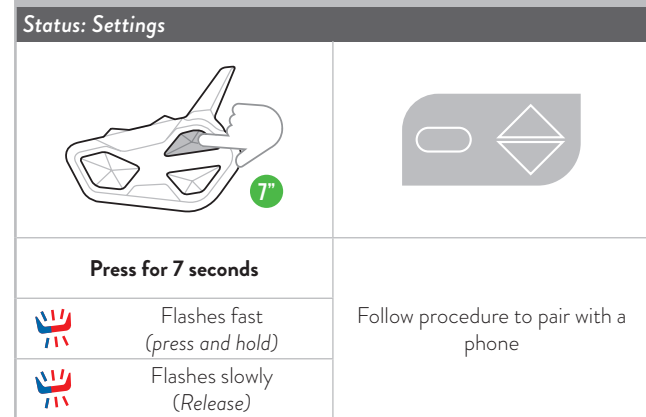

### PAIRING 4 UNITS IN CONFERENCE

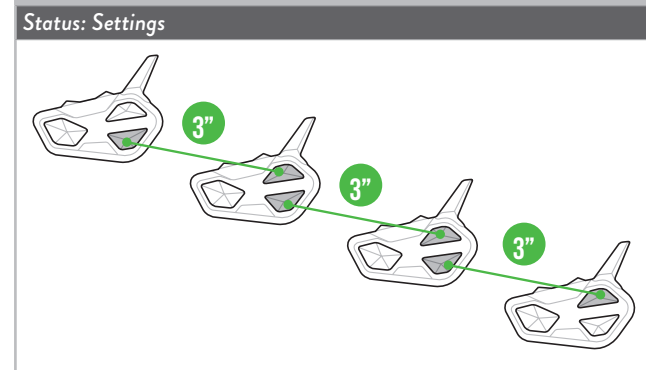

**Note:** the Conference mode allows the simultaneous communication amongst units. All units must be paired in a "chain" configuration: the Down button of the first unit must be paired to the Up button of the second unit and so on. For a detailed description of the function go to paragraph "Conference" of the complete user manual or watch the video tutorial

### RESET BLUETOOTH PAIRINGS

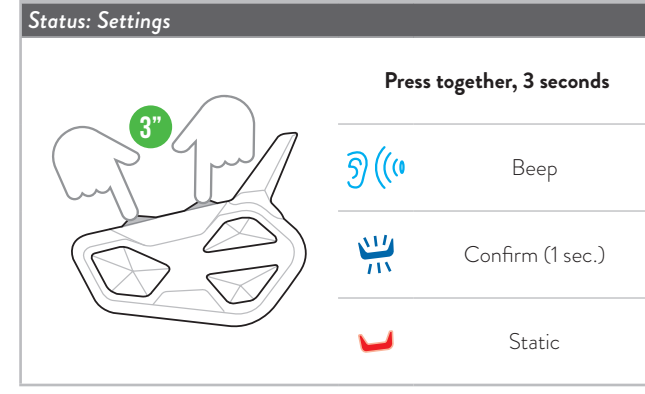

### EXIT SETTINGS MODE CANCEL PAIRING

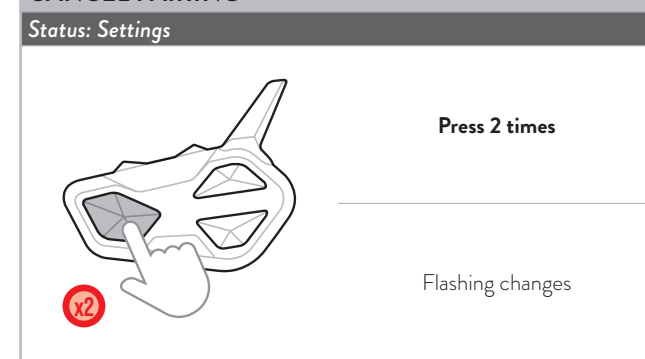

Frequency (GHz)	Max power (mW)
2.402 - 2.480	100

Go to our website [midlandeuropa.com](http://midlandeuropa.com), download the complete manual and the BT Updater software.

Customize your intercom and discover all the functions with the **BT PRO SetApp**. Download it here:

POCKET GUIDE

## BTR1 ADVANCED

Bike to Bike Conference Communication



HIGH DEFINITION SOUND BY **RCF**



ENGLISH

# OPERATING MODES

- A. **Intercom Mode:** to communicate with another device.
- B. **Phone Mode:** for phone calls or for managing music.
- C. **FM Radio Mode:** to listen to radio, search and store stations.

**Note:** Phone mode and Intercom mode are enabled only when your intercom is paired to other devices.

## CHOOSE OPERATING MODE

Status: device on

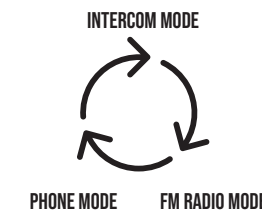

Press for 3 seconds to change mode or press and hold to scroll quickly

Operating mode status

**Note:** By pressing simultaneously Vol + and Vol -, BTR1 Advanced communicates the selected operating mode.

## INTERCOM MODE

### FUNCTION DESCRIPTION

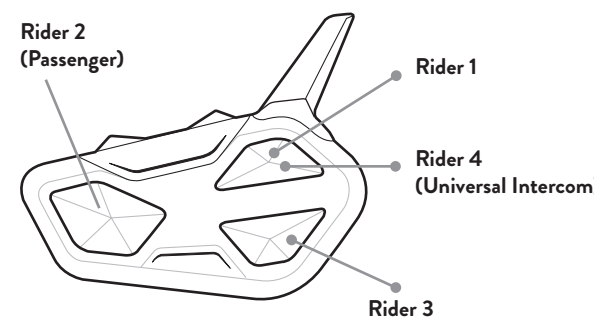

### TO OPEN/CLOSE INTERCOM MANUALLY

Status: Intercom mode



**Note:** to communicate with Rider 1/3 repeat the process pressing the Up/ (Rider 1)/Down (Rider 3) buttons.

### VOX ACTIVATION/DEACTIVATION

Status: in all modes



### TO OPEN/CLOSE INTERCOM BY VOICE

Status: in all modes

- Say "Hi"
- Voice announcement
- Flashes
- Silent for 40 sec. **the intercom deactivates**
- Beep

**Note:** Voice activation is only possible when the intercom device is paired with the **Control** button.

**SHORTCUT:** In Intercom/FM radio modes pressing Control 2 times activates/deactivates the music.

### TO OPEN/CLOSE UNIVERSAL INTERCOM

Status: Intercom mode

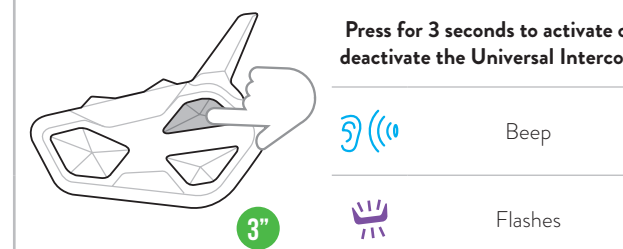

**Note:** to activate/deactivate the audio from a different brand device, use the voice call command (for some models it is necessary to send the voice call twice)

### TO ENABLE/DISABLE THE CONFERENCE MODE

Status: in all modes

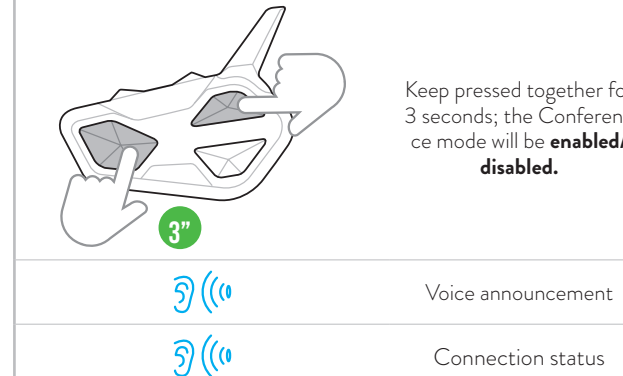

**Note:** in Conference mode, the devices paired to Vol+/Vol- are temporarily disconnected.

### TO OPEN/CLOSE CONFERENCE

Status: Conference mode

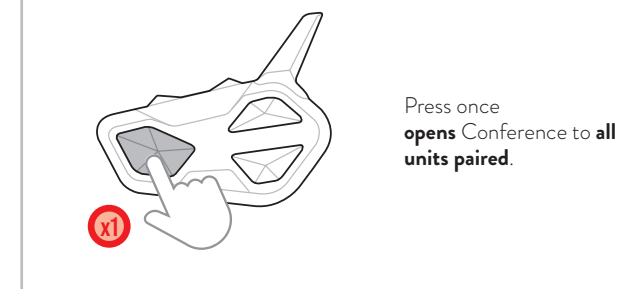

## PHONE MODE

### FUNCTION DESCRIPTION

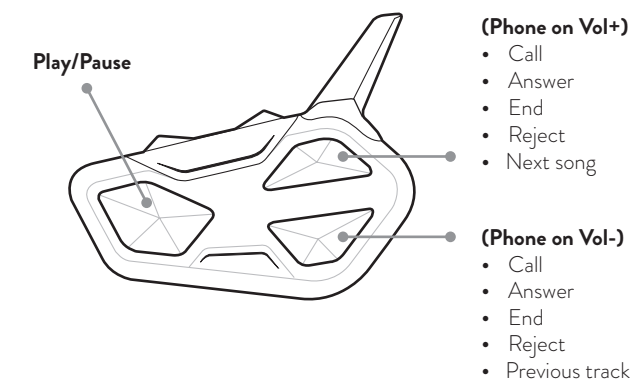

### MAKING A CALL

Status: Phone mode

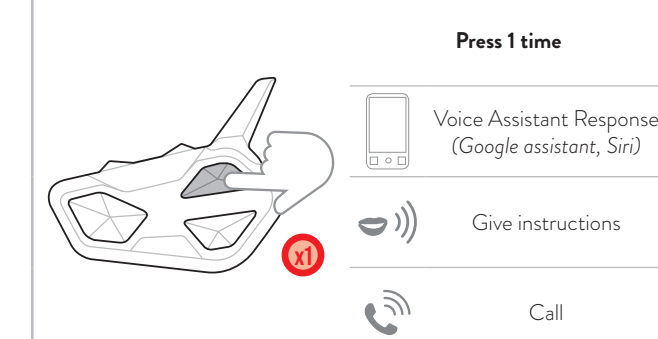

**Note:** If you have a phone paired with the Vol - button, use the Down button.

**SHORTCUT:** In Phone mode by pressing the UP/DOWN buttons twice, turns the Intercom on/off (Rider 1, 3).

### ANSWERING/ENDING A CALL - REJECTING A CALL

Status: All modes

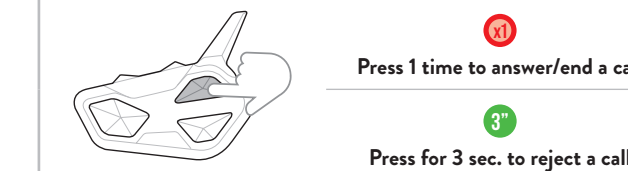

**Note:** If you have a phone paired with the Vol - button, use the Down button.

### MUSIC

Status: Phone mode

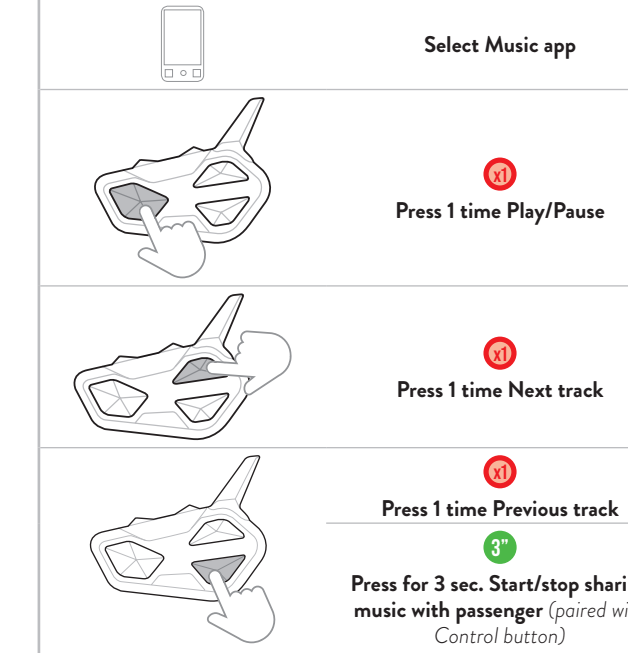

## RADIO MODE

### FUNCTION DESCRIPTION

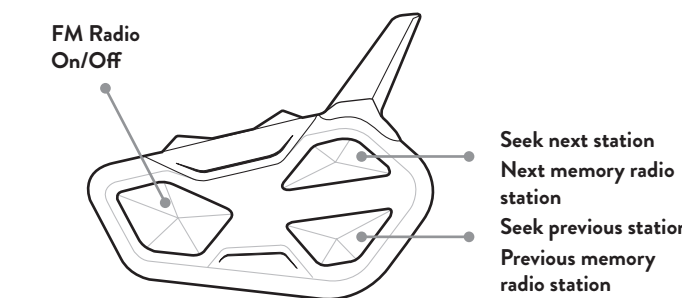

### FM RADIO

Status: Radio mode

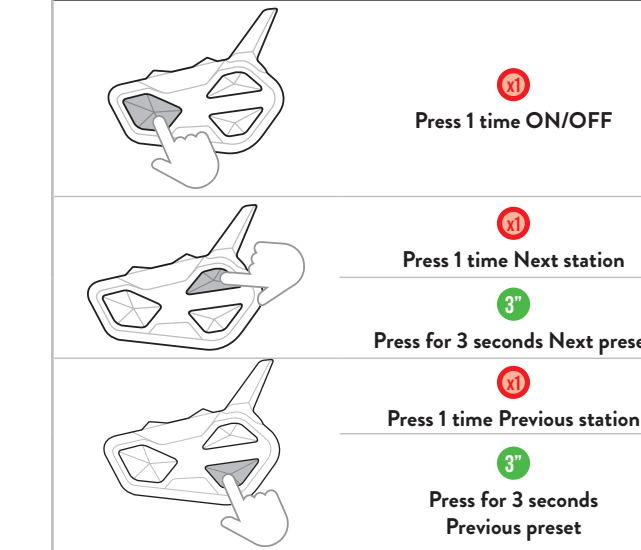

## ON/OFF

### DESCRIZIONE TASTI

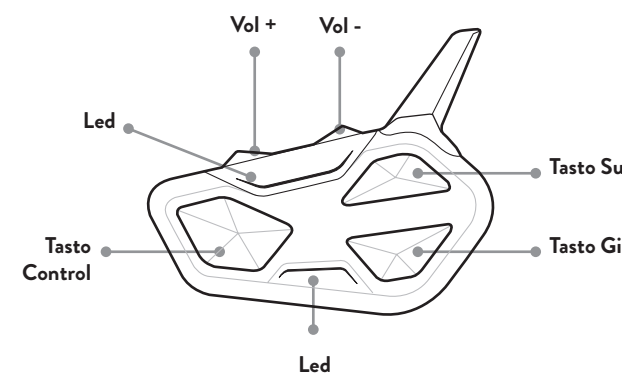

### ACCENSIONE

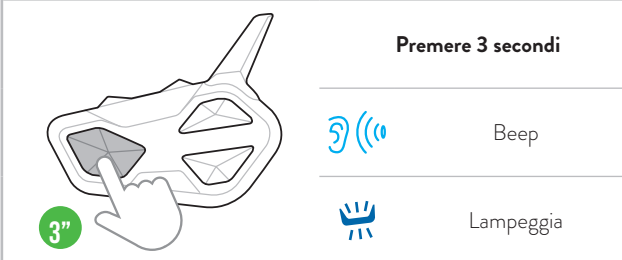

### SPEGNIMENTO

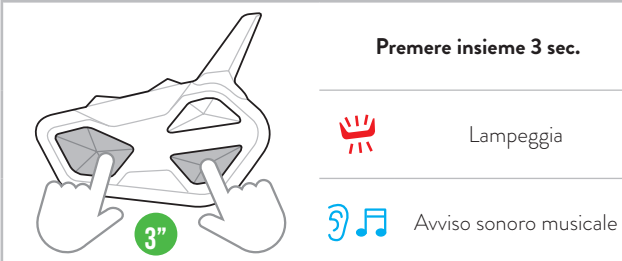

## ABBINAMENTI

### DESCRIZIONE TASTI

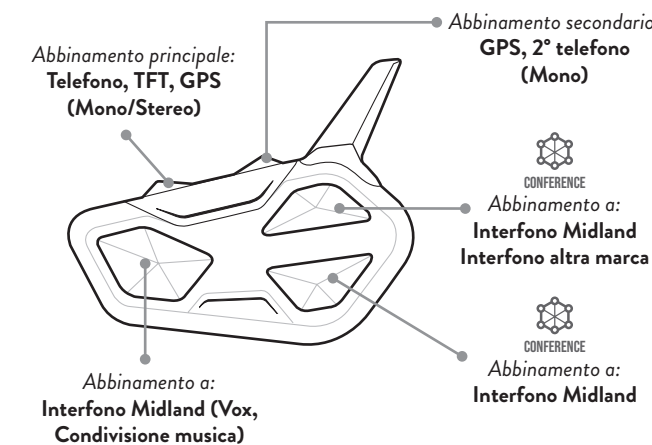

**ATTENZIONE:** Per effettuare qualsiasi abbinamento è necessario entrare in Impostazioni. Se premete il tasto Control meno di 7 secondi, il dispositivo si accenderà anziché entrare in Impostazioni. In tal caso ripetere l'operazione.

### ENTRARE IN IMPOSTAZIONI

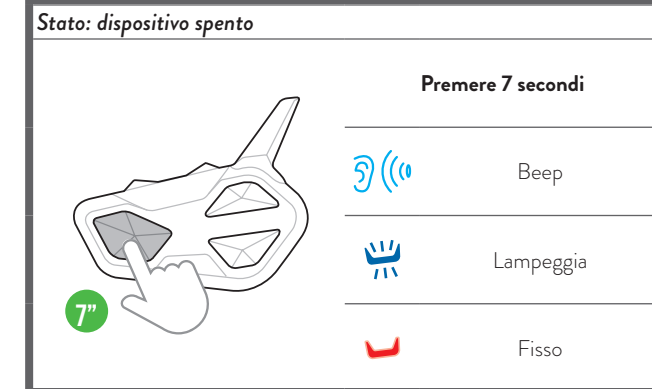

### ABBINAMENTO TELEFONO, GPS, TFT

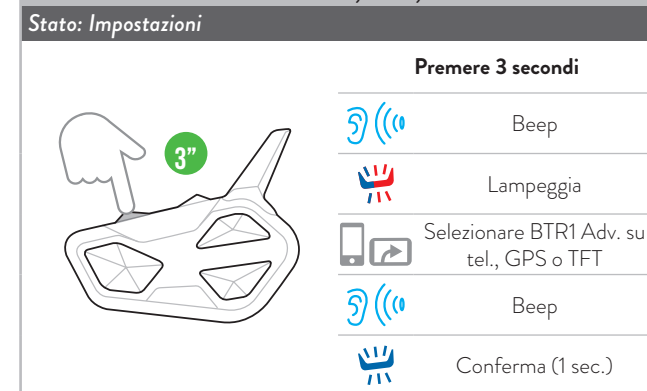

**Nota:** per abbinare un 2° dispositivo in audio mono, ripetere questa procedura utilizzando Vol -.

### ABBINAMENTO INTERFONO MIDLAND

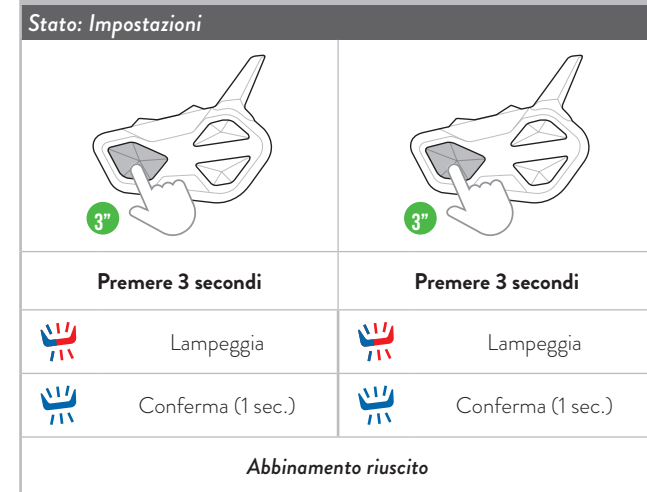

**Nota:** per abbinare un altro interfono Midland, seguire la stessa procedura utilizzando i tasti Su/Giù.

### ABBINAMENTO INTERFONO ALTRA MARCA (UNIVERSAL INTERCOM)

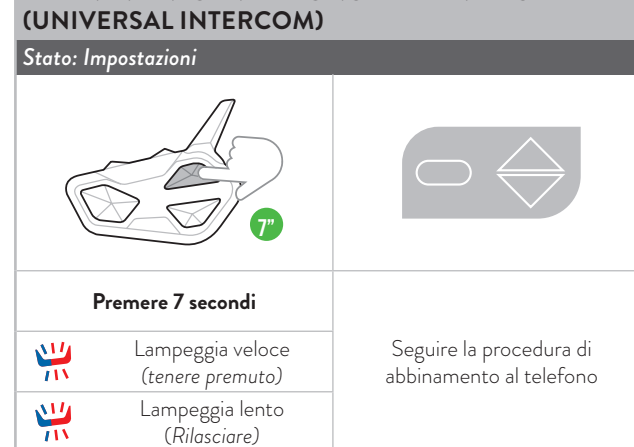

### ABBINAMENTO A 4 INTERFONI IN CONFERENCE

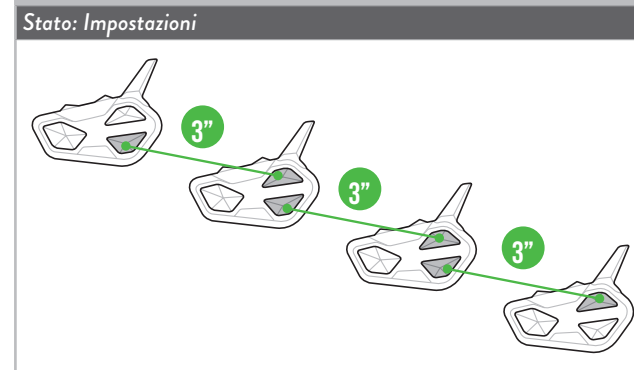

**Nota:** La modalità Conference permette la comunicazione contemporanea di più dispositivi. È necessario abbinare i dispositivi a "catena", ovvero il pulsante "Giù" del primo dispositivo deve essere abbinato al pulsante "Su" del secondo, e così via. Per maggiori dettagli consultate il paragrafo "Conference" sul manuale d'uso o il Video Tutorial.

### RESET ABBINAMENTI BLUETOOTH



### USCIRE DALLA MODALITÀ IMPOSTAZIONI INTERROMPERE L'ABBINAMENTO

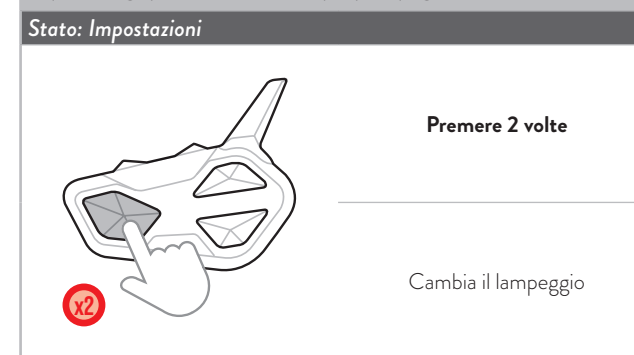

Frequenza (GHz)	Potenza max (mW)
2.402 - 2.480	100

Vai sul sito [midlandeurope.com](http://midlandeurope.com), scarica il manuale completo e il software BT Updater.

Personalizza il tuo interfono e scopri tutte le funzioni con **BTPRO SetApp**. Scaricala qui:



## BTR1 ADVANCED

Bike to Bike Conference Communication



HIGH DEFINITION SOUND BY **RCF**



## MODALITÀ OPERATIVE

- A. **Modalità Intercom:** per comunicare con un altro dispositivo.  
 B. **Modalità telefono:** per chiamate telefoniche o per gestire la musica.  
 C. **Modalità radio FM:** per ascoltare, cercare e memorizzare stazioni radio.

**Nota:** Le modalità Intercom e Telefono sono attive solo quando ci sono dei dispositivi abbinati.

### SELEZIONARE LA MODALITÀ OPERATIVA

Stato: dispositivo acceso

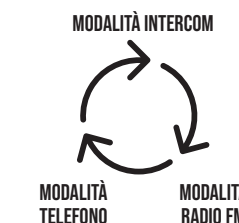

**Premere 3 secondi** per cambiare modalità o tenere premuto per scorrerle velocemente

Stato modalità operativa

**Nota:** Premendo contemporaneamente Vol + e Vol -, BTR1 Advanced comunica la modalità operativa selezionata.

### MODALITÀ INTERCOM

#### DESCRIZIONE FUNZIONI

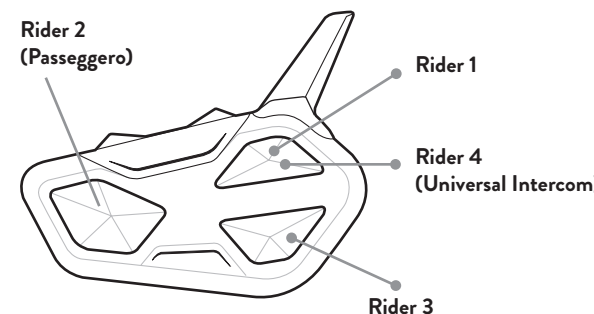

#### APRIRE/CHIUDERE INTERCOM MANUALMENTE

Stato: modalità Intercom



**Nota:** per comunicare con Rider 1/3 ripetere l'operazione premendo il tasto Su (Rider 1)/Giù (Rider 3).

#### ATTIVARE/DISATTIVARE IL VOX

Stato: in tutte le modalità

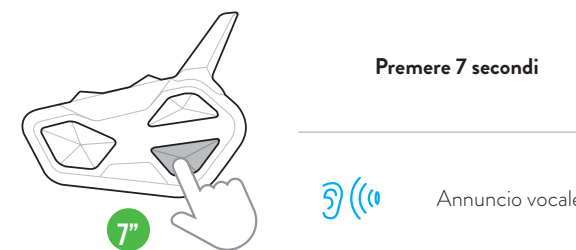

#### APRIRE/CHIUDERE L'INTERCOM VOCALMENTE

Stato: in tutte le modalità

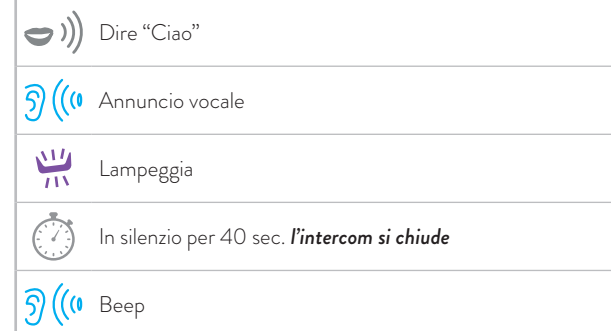

**Nota:** l'attivazione vocale è possibile solo con un interfono abbinato al tasto Control.

**SHORTCUT:** In modalità Intercom/FM Radio premendo 2 volte Control attivi/disattivi la musica.

#### APRIRE/CHIUDERE UNIVERSAL INTERCOM

Stato: modalità Intercom

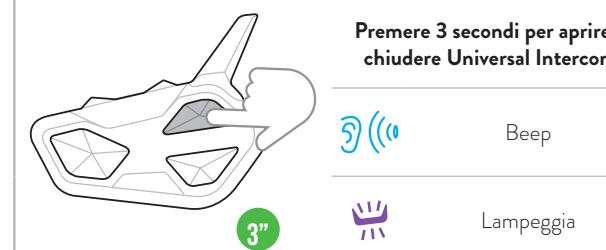

**Nota:** per aprire/chiudere l'audio dal dispositivo di altra marca, utilizzare il comando di chiamata vocale (per alcuni modelli è necessario inviare la chiamata vocale 2 volte)

#### ATTIVARE/DISATTIVARE CONFERENCE

Stato: in tutte le modalità

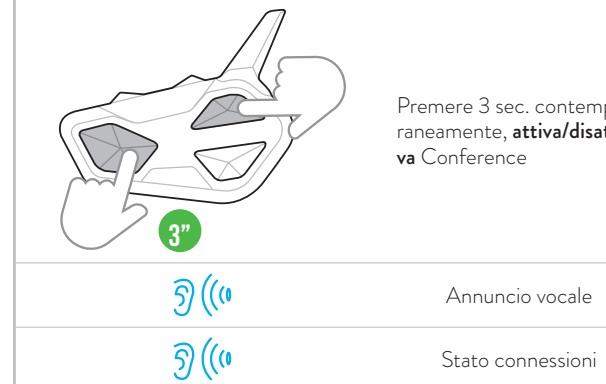

**Nota:** Durante la Conference, i dispositivi abbinati a Vol+/Vol- sono momentaneamente scollegati.

#### APRIRE/CHIUDERE CONFERENCE

Stato: Conference

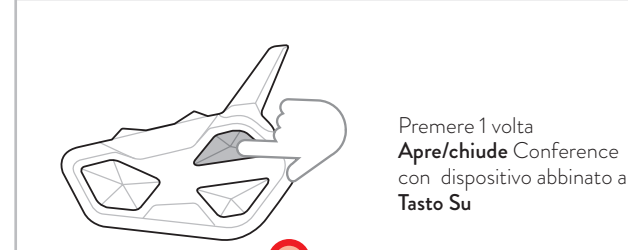

**Nota:** Premere 1 volta Apre/chiude Conference con dispositivo abbinato al Tasto Su

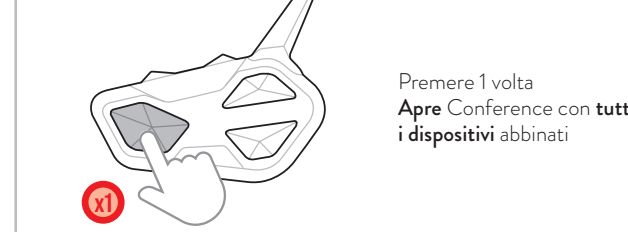

**Nota:** Premere 1 volta Apre/chiude Conference con tutti i dispositivi abbinati

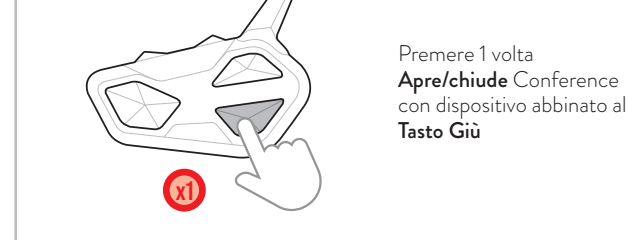

**Nota:** Premere 1 volta Apre/chiude Conference con dispositivo abbinato al Tasto Giù

### MODALITÀ TELEFONO

#### DESCRIZIONE FUNZIONI

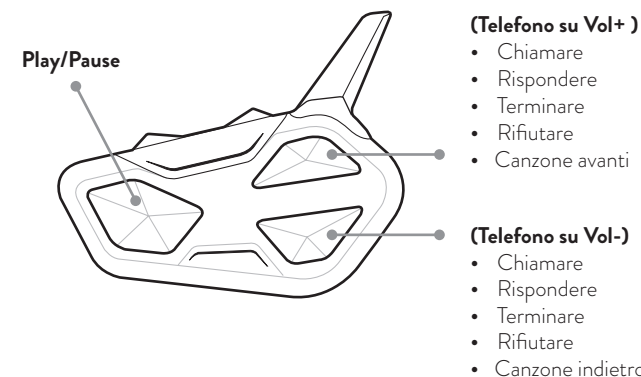

#### EFFETTUARE UNA CHIAMATA

Stato: modalità Telefono

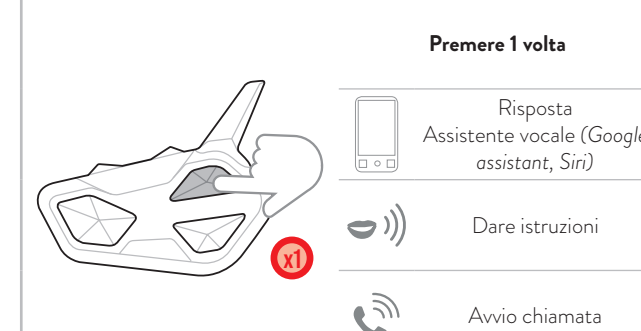

**Nota:** se avete un telefono abbinato al tasto Vol -, utilizzate il tasto Giù.

**SHORTCUT:** Nelle modalità Telefono premendo 2 volte Up/Down, apri/chiudi l'Intercom (Rider 1, 3).

### RISPONDERE/TERMINARE UNA CHIAMATA

#### RIFIUTARE UNA CHIAMATA

Stato: in tutte le modalità

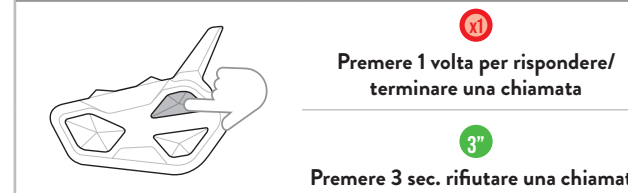

**Nota:** se avete un telefono abbinato al tasto Vol -, utilizzate il tasto Giù.

#### MUSICA

Stato: modalità Telefono

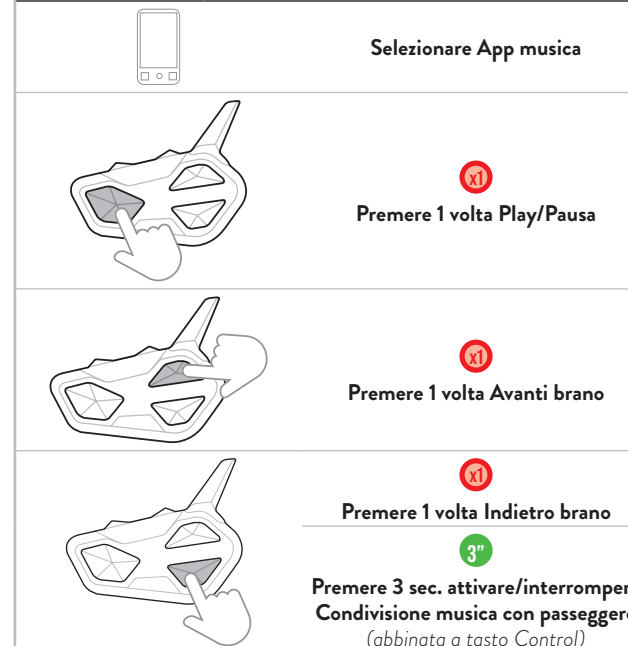

### MODALITÀ RADIO

#### DESCRIZIONE FUNZIONI

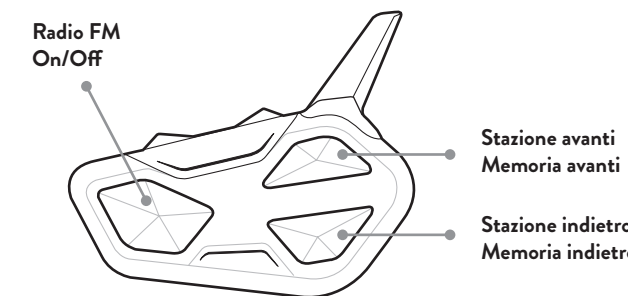

#### RADIO FM

Stato: modalità Radio

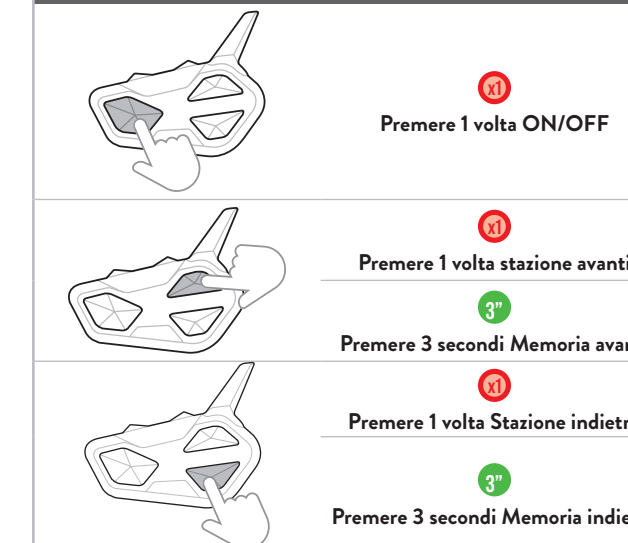

## EIN-/AUSSCHALTEN

### TASTENBESCHREIBUNG

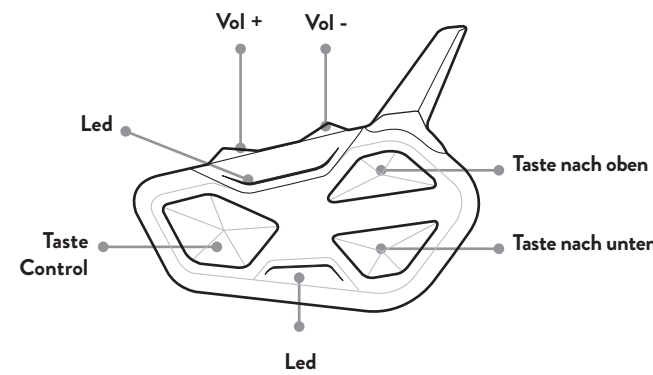

### EINSCHALTEN

	3 Sekunden drücken
	Pfeifton
	Blinkt

### AUSSCHALTEN

	3 Sekunden zusammen drücken
	Blinkt
	Musikalischer Benachrichtigungston

## VERBINDUNGEN

### TASTENBESCHREIBUNG

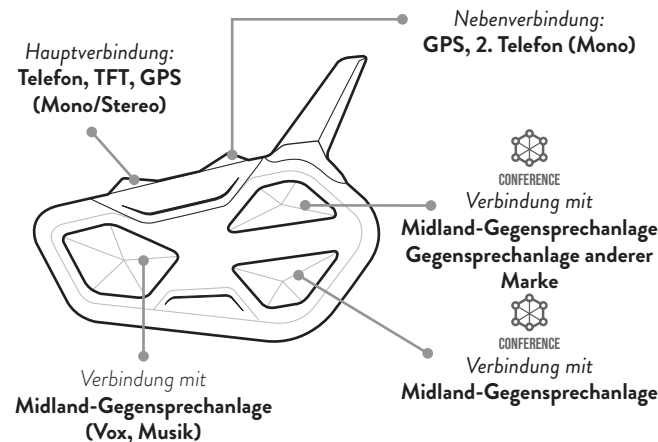

**ACHTUNG:** Zur Herstellung jeglicher Verbindungen, ist das Öffnen der Einstellungen erforderlich. Wenn Sie die Taste Control weniger als 7 Sekunden drücken, schaltet sich das Gerät ein, anstatt die Einstellungen zu öffnen. In diesem Fall den Vorgang wiederholen.

### EINSTELLUNGEN ÖFFNEN

	7 Sekunden drücken
	Pfeifton
	Blinkt
	Durchgehend

### VERBINDUNG MIT TELEFON, GPS, TFT

	3 Sekunden drücken
	Pfeifton
	Blinkt
	BTR1 Ad. auf Telefon, GPS oder TFT auswählen
	Pfeifton
	Bestätigung (1 Sek.)

**Hinweis:** Zum Verbinden eines zweiten Geräts in Mono-Audio diesen Vorgang mit **Vol** - wiederholen.

### VERBINDUNG MIT MIDLAND-GEGENSPRECHANLAGE

	3 Sekunden drücken		3 Sekunden drücken
	Blinkt		Blinkt
	Bestätigung (1 Sek.)		Bestätigung (1 Sek.)
Verbindung hergestellt			

**Hinweis:** Um eine weitere Midland Gegensprechanlage zu verbinden, den gleichen Vorgang mit der **Taste nach oben** (Rider 1)/nach unten (Rider 3) ausführen.

### VERBINDUNG MIT GEGENSPRECHANLAGE ANDERER MARKE (UNIVERSAL INTERCOM)

	7 Sekunden drücken		Den Vorgang zur Verbindung mit dem Telefon befolgen
	Blinkt schnell (gedrückt halten)		
	Blinkt langsam (loslassen)		

### RESET DER BLUETOOTH-VERBINDUNGEN

	Zusammen drücken, 3 Sekunden
	Pfeifton
	Bestätigung (1 Sek.)
	Durchgehend

Frequenz (GHz)	Max Leistung (mW)
2,402 - 2,480	100

### 4 GERÄTE IN KONFERENZ VERBINDEN

**Hinweis:** der Konferenzmodus erlaubt die gleichzeitige Kommunikation aller Geräte. Die Geräte werden als "Kette" verbunden: die Unten-Taste des 1. Gerätes muss mit der Oben-Taste des 2. Gerätes usw. gekoppelt sein. Für eine ausführliche Beschreibung schauen Sie in der Gesamtanleitung im Kapitel "Konferenz" oder im Tutorial-Video nach.

### DEN MODUS EINSTELLUNGEN VERLASSEN VERBINDUNG UNTERBRECHEN

	2 Mal drücken
	Das Blinken ändert sich

Besuchen Sie die Website [midland.de](http://midland.de) zum Herunterladen des vollständigen Handbuchs und der Software **BT Updater**.

Gestalten Sie Ihre Gegensprechanlage mit der **BTPRO SetApp** individuell. Laden Sie sie hier herunter:

KURZANLEITUNG

## BTR1 ADVANCED

Bike to Bike Conference Communication



HIGH DEFINITION SOUND BY **RCF**



DEUTSCH

# BETRIBSMODI

- A. Intercom-Modus:** Für die Kommunikation mit einem anderen Gerät.
  - B. Telefon-Modus:** Für Telefonanrufe oder zur Steuerung von der Musik.
  - C. UKW-Radio-Modus:** Zum Anhören, Suchen und Speichern von Radiostationen.
- Hinweis: Der Telefon-Modus ist nur aktiv, wenn Ihre Gegensprechanlage mit einem entsprechenden Gerät gekoppelt ist.*

## BETRIBSMODUS AUSWÄHLEN

Status: Gerät eingeschaltet

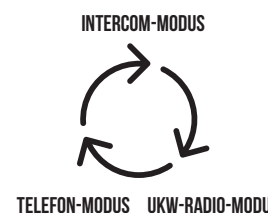

**3 Sekunden drücken**, um die Betriebsmodi zu ändern oder gedrückt halten, um sie schnell zu durchlaufen

Status Betriebsmodus

*Hinweis: Durch gleichzeitiges Drücken von Vol + und Vol - 1 Sekunde lang teilt BTR1 Advanced den ausgewählten Modus mit.*

## INTERCOM-MODUS

### BESCHREIBUNG DER FUNKTIONEN

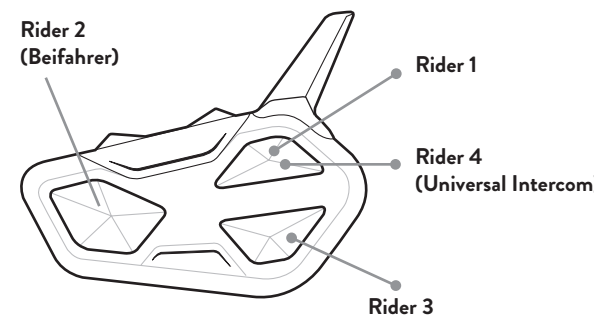

### MANUELLES ÖFFNEN/SCHLIESSEN DES INTERCOM

Status: Intercom-Modus



*Hinweis: Zum Kommunizieren mit Rider 1/3 den Vorgang wiederholen, indem die Taste nach oben /nah Unten (Rider 3) betätigt wird.*

**SHORTCUT:** Im Intercom-/UKW-Radio-Modus wird die Musik durch 2-maliges Drücken von Control ein-/ausgeschaltet.

### AKTIVIERUNG/DEAKTIVIERUNG VON VOX

Status: in allen Modi

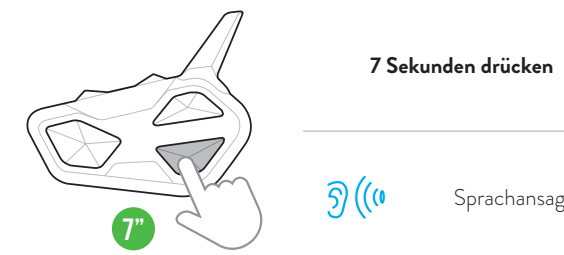

### ÖFFNEN/SCHLIESSEN DES INTERCOM DURCH SPRACHSIGNAL

Status: in allen Modi

- „Hallo“ sagen
- Sprachansage
- Blinkt
- Nach 40 Sek. Stille wird die Kommunikation geschlossen
- Pfeifton

*Hinweis: Die Sprachaktivierung ist nur mit der Taste Control verbundener Gegensprechanlage möglich.*

### ÖFFNEN/SCHLIESSEN VON UNIVERSAL INTERCOM

Status: Intercom-Modus



*Hinweis: Verwenden Sie den Sprachbefehl, um das Audio von einem Gerät einer anderen Marke zu öffnen/schließen (für einige Modelle ist es notwendig, den Sprachbefehl 2 Mal zu senden)*

### KONFERENZ AKTIVIEREN/DEAKTIVIEREN

Status: in allen Modi

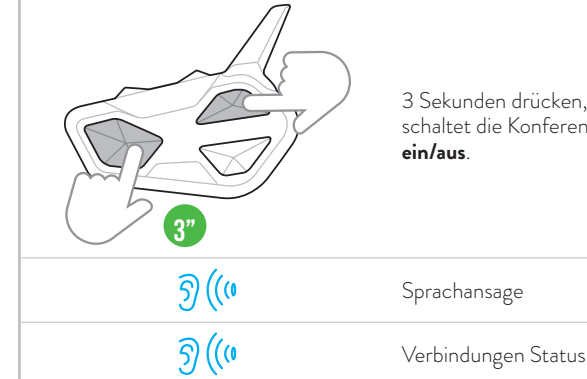

**Anmerkung:** Die Geräte mit Pairing Vol+/- sind vorübergehend nicht verbunden.

### KONFERENZ ÖFFNEN/SCHLIESSEN

Status: Konferenz

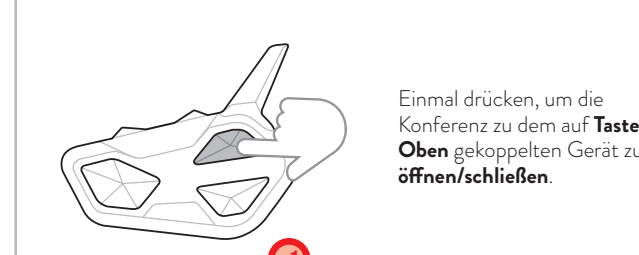

Einmal drücken, um die Konferenz zu dem auf **Taste Oben** gekoppelten Gerät zu öffnen/schließen.

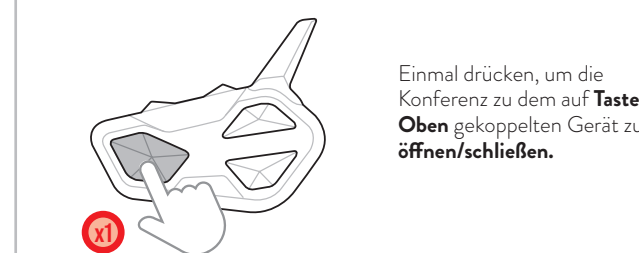

Einmal drücken, um die Konferenz zu dem auf **Taste Unten** gekoppelten Gerät zu öffnen/schließen.



## TELEFON-MODUS

### BESCHREIBUNG DER FUNKTIONEN

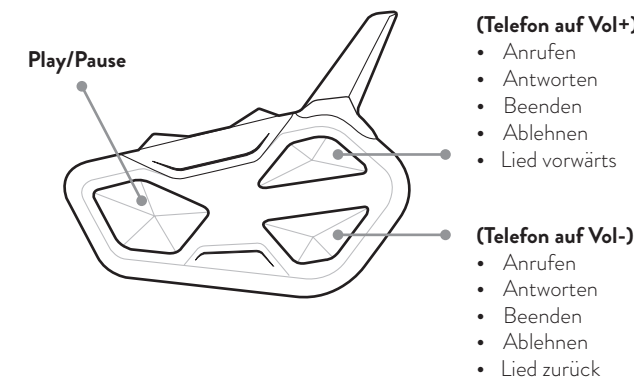

### TÄTIGEN EINES ANRUF

Status: Telefon-Modus



*Hinweis: Wenn Sie ein Telefon mit der Taste Vol- verbunden haben, verwenden Sie die Taste nach unten.*

**SHORTCUT:** In dem Telefon-Modus wird das Intercom durch 2-maliges Drücken der Taste Up/Down geöffnet/geschlossen (Rider 1, 3).

## ANNEHMEN/BEENDEN EINES ANRUF

Status: in allen Modi



*Hinweis: Wenn Sie ein Telefon mit der Taste Vol- verbunden haben, verwenden Sie die Taste nach unten.*

## MUSIK

Status: Telefon-Modus



## RADIO-MODUS

### BESCHREIBUNG DER FUNKTIONEN

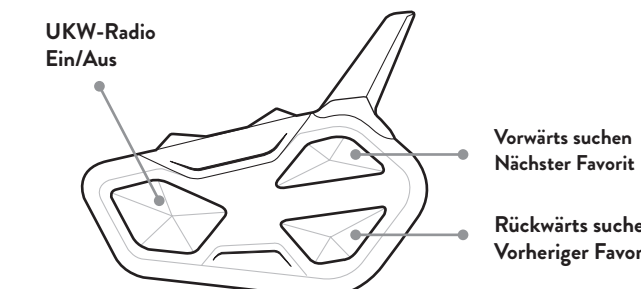

### UKW-RADIO

Status: Radio-Modus

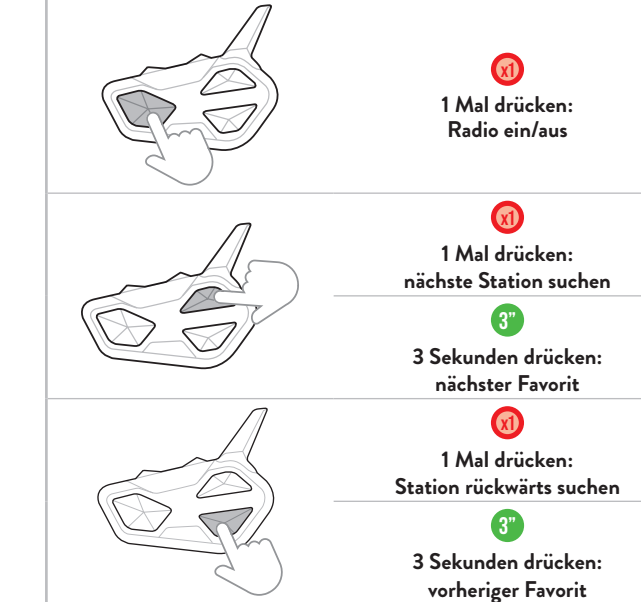

## ON/OFF

### DESCRIPCIÓN DE LOS BOTONES

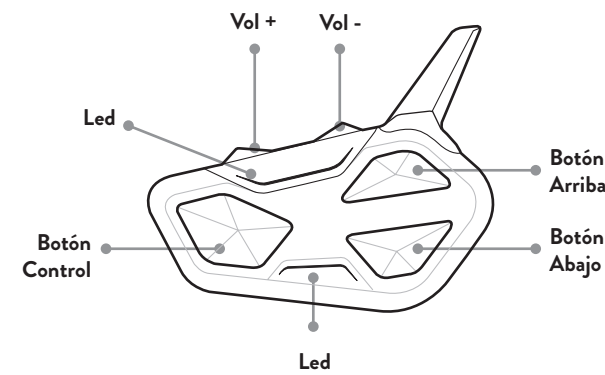

### ENCENDIDO



### APAGADO

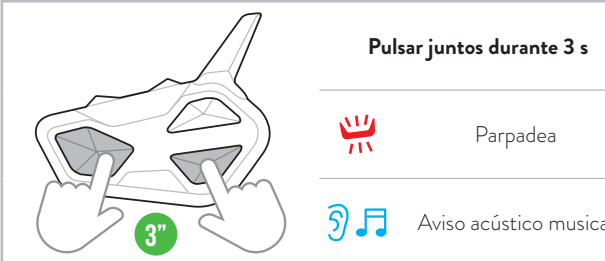

## EMPAREJAMIENTO

### DESCRIPCIÓN DE LOS BOTONES

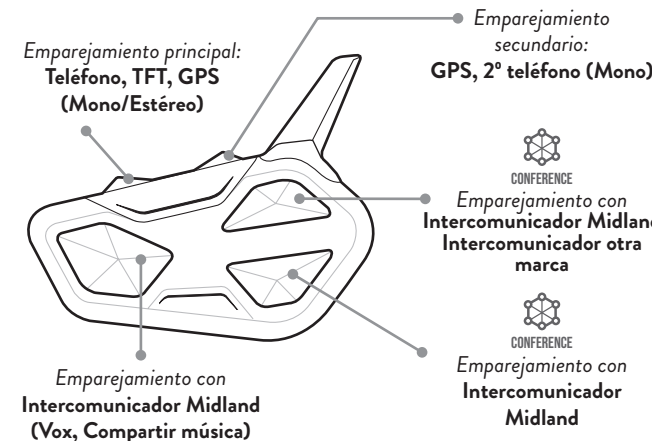

**ATENCIÓN:** para realizar cualquier tipo de emparejamiento, entrar en Ajustes. Si se pulsa el botón Control durante menos de 7 segundos, el dispositivo se encenderá en lugar de entrar en Ajustes. En este caso, repetir la operación.

### ENTRAR EN AJUSTES

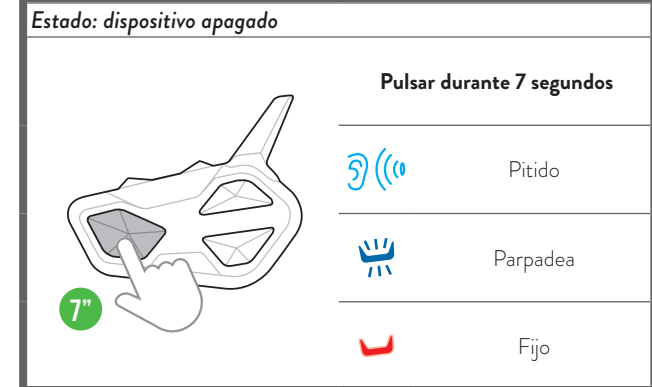

### EMPAREJAMIENTO TELÉFONO, GPS, TFT

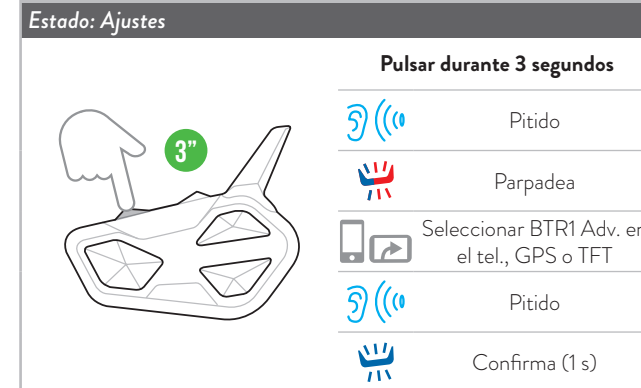

**Nota:** para emparejar un 2º dispositivo en audio mono, repetir este procedimiento utilizando Vol -.

### EMPAREJAMIENTO CON 4 UNIDADES EN CONFERENCIA

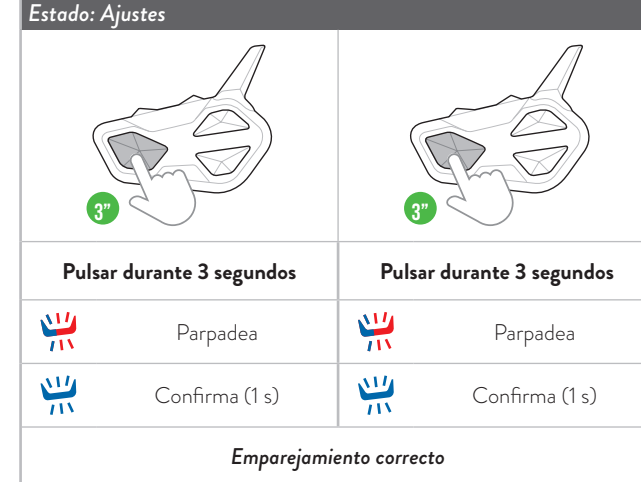

**Nota:** para emparejar otro intercomunicador Midland, seguir el mismo procedimiento utilizando el botón Arriba/Abajo.

### EMPAREJAMIENTO INTERCOMUNICADOR DE OTRA MARCA (UNIVERSAL INTERCOM)

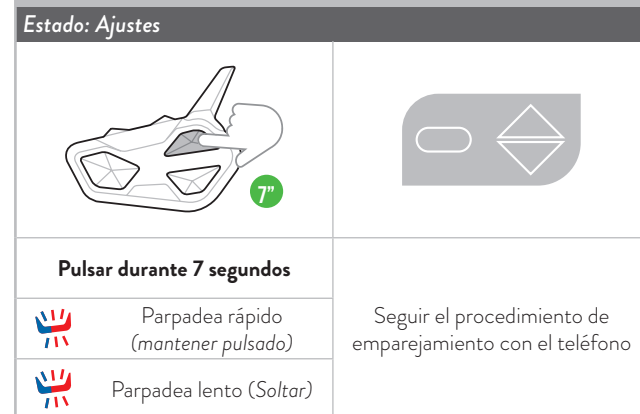

### COMBINACIÓN DE 4 INTERFONOS EN CONFERENCIA

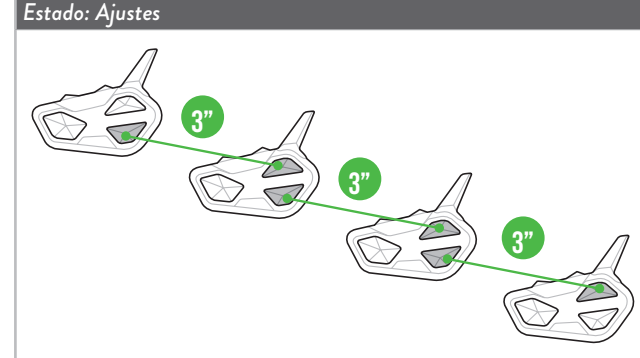

**Nota:** el modo "Conferencia" permite la comunicación simultánea de varios dispositivos. Para usar dicha función, los dispositivos deben estar enlazados en modo "cadena": enlazar el botón "Abajo" del primer intercomunicador al botón "Arriba" del segundo, y así sucesivamente. Para más información, ver el párrafo "Conferencia" del manual de usuario o el videotutorial.

### REINICIAR EMPAREJAMIENTOS BLUETOOTH



### SALIR DEL MODO DE AJUSTES INTERRUPTIR EL EMPAREJAMIENTO

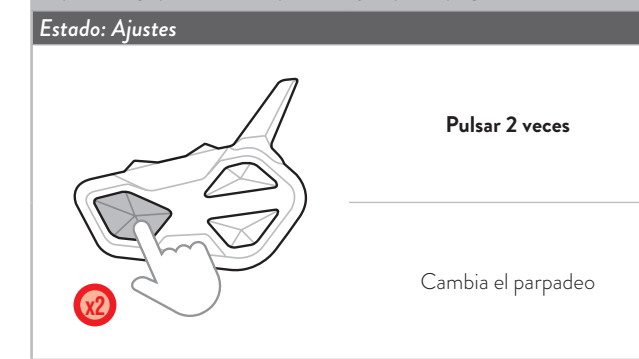

Frecuencia (GHz)	Potencia máx (mW)
2.402 - 2.480	100

Visita el sitio web [midlandeurope.com](http://midlandeurope.com), descarga el manual completo y el software BT Updater.

Personaliza el intercomunicador y descubre todas las funciones con con BTPRO SetApp. Descárgala aquí:



## BTR1 ADVANCED

Bike to Bike Conference Communication



HIGH DEFINITION SOUND BY RCF



## MODOS DE FUNCIONAMIENTO

- A. **Modo Intercom:** para comunicarse con otro dispositivo.  
 B. **Modo teléfono:** para llamar por teléfono o para gestionar la música.  
 C. **Modo radio FM:** para escuchar, buscar y memorizar las emisoras de radio.

**Nota:** los modos de intercomunicación y teléfono están activos solo cuando hay dispositivos emparejados con los botones Vol+/Vol-.

### SELECCIONAR EL MODO DE FUNCIONAMIENTO

Estado: dispositivo encendido

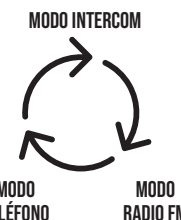

Pulsar durante 3 segundos para cambiar el modo o mantener pulsado para pasarlos rápidamente

Estado modo de funcionamiento

**Nota:** al pulsar simultáneamente Vol + y Vol - durante 1 segundo, BTR1 Advanced comunica el modo de funcionamiento seleccionado.

### MODO INTERCOM

#### DESCRIPCIÓN DE LAS FUNCIONES

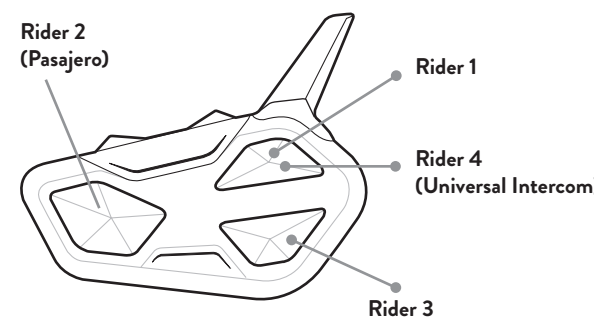

#### ABRIR/CERRAR EL INTERCOMUNICADOR MANUALMENTE

Estado: modo Intercom



**Nota:** para comunicarse con Rider 1/3, repetir la operación pulsando el botón Arriba (rider 1)/Abajo rider 3).

#### ACTIVAR/DESACTIVAR EL VOX

Estado: en todos los modos

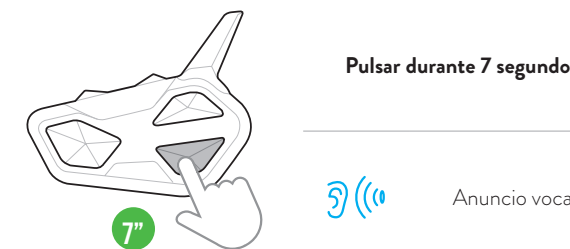

#### ABRIR/CERRAR EL INTERCOMUNICADOR CON LA VOZ

Estado: en todos los modos

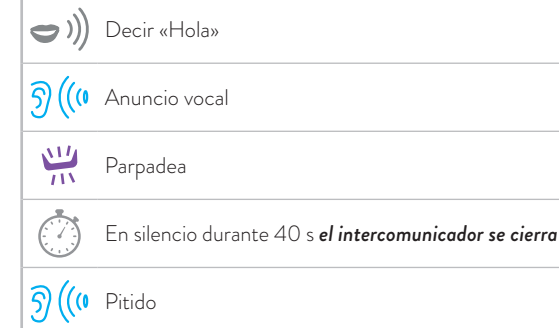

**Nota:** la activación con la voz se puede realizar con un intercomunicador emparejado con el botón Control.

**ATAJO:** Play/Pausa de la música en modo Intercom/Radio FM: pulsar 2 veces la tecla Control.

#### ABRIR/CERRAR UNIVERSAL INTERCOM

Estado: modo Intercom



**Nota:** para abrir/cerrar el audio desde el dispositivo de otra marca, utilizar el comando de llamada de voz (en algunos modelos es necesario enviar 2 veces la llamada de voz)

#### ACTIVAR/DESACTIVAR CONFERENCIA

Estados: en todos los modos



**Nota:** los dispositivos emparejados en Vol+/- se desconectan temporalmente

#### ABRIR/CERRAR CONFERENCIA

Estado: Conferencia



### MODO TELÉFONO

#### DESCRIPCIÓN DE LAS FUNCIONES

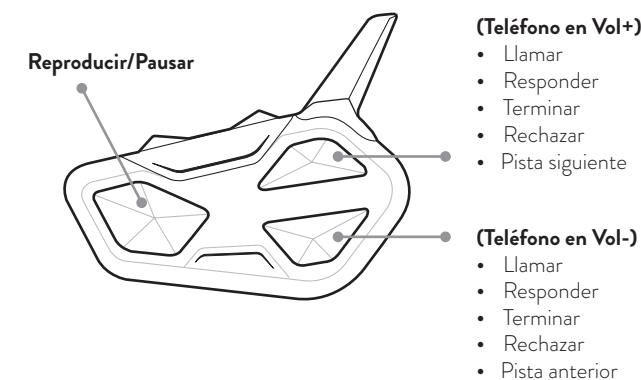

#### REALIZAR UNA LLAMADA

Estado: modo Teléfono

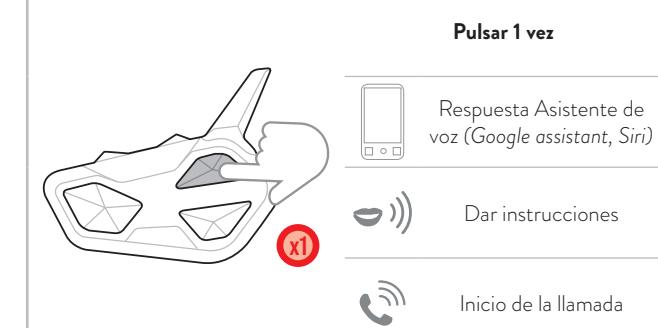

**Nota:** si el teléfono está emparejado con el botón Vol -, utilizar el botón Abajo.

**ATAJO:** en el modo Teléfono, pulsando 2 veces el botón Up/Down, se abre/cierra el Intercomunicador (Rider 1, 3).

#### RESPONDER/TERMINAR UNA LLAMADA RECHAZAR UNA LLAMADA

Estado: en todos los modos

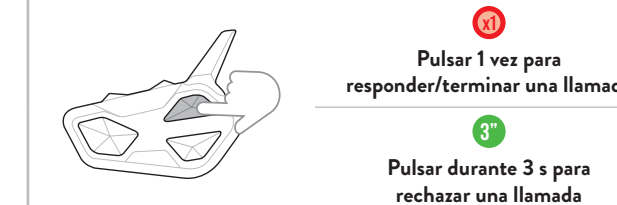

**Nota:** si el teléfono está emparejado con el botón Vol -, utilizar el botón Abajo.

#### MÚSICA

Estado: modo Teléfono

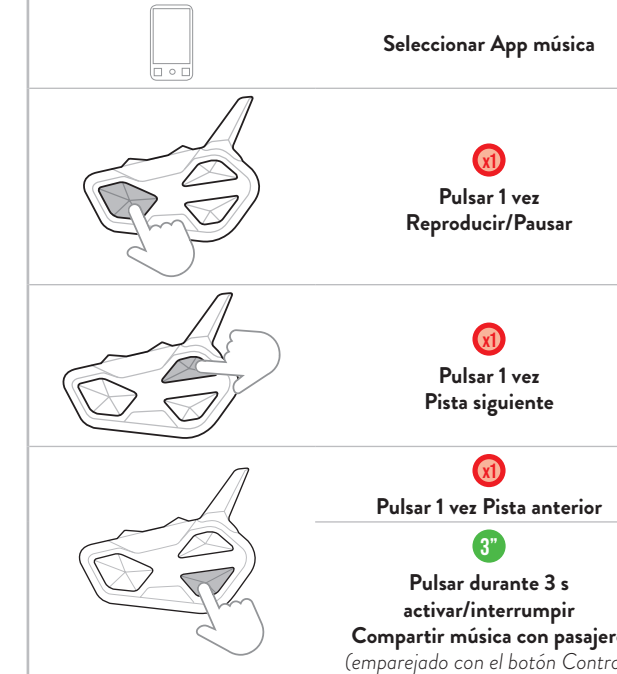

### MODO RADIO

#### DESCRIPCIÓN DE LAS FUNCIONES

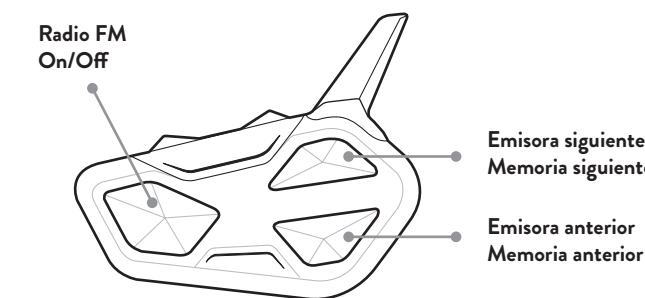

#### RADIO FM

Estado: modo Radio

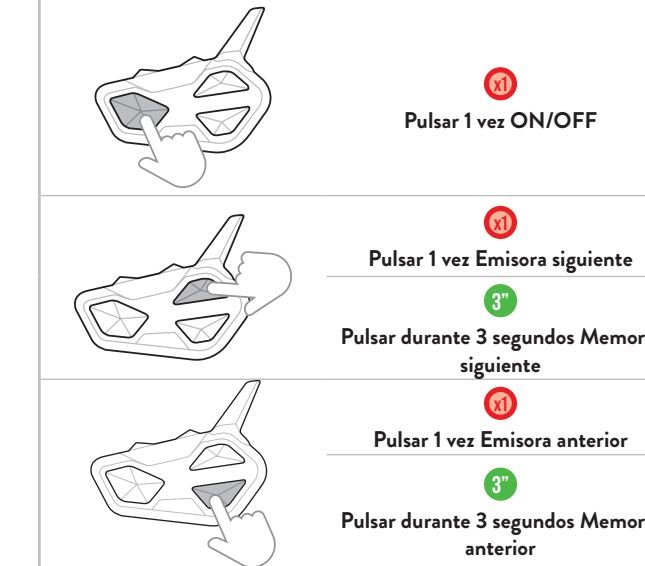



## ON/OFF

### DESCRIPTION DES TOUCHES

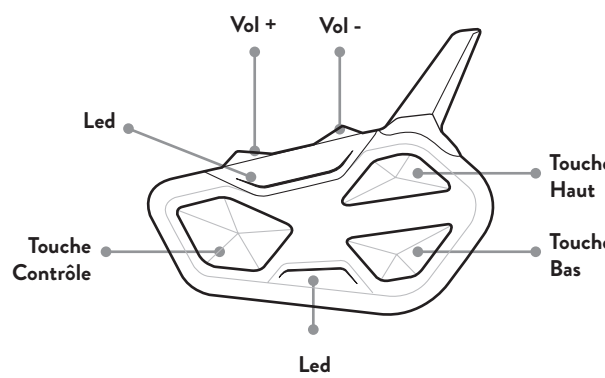

### POUR ALLUMER

Appuyer pendant 3 secondes

	Bip
	Clignote

### POUR ÉTEINDRE

Appuyer simultanément 3 s

	Clignote
	Signal sonore musical

## APPAIRAGES

### DESCRIPTION DES TOUCHES

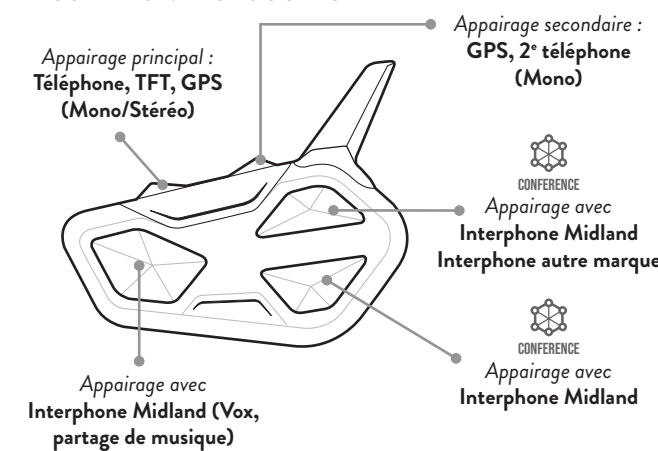

**ATTENTION :** Pour effectuer n'importe quel appairage il faut entrer dans Configurations. Si l'on appuie sur la touche Contrôle pendant moins de 7 secondes, l'appareil s'allume au lieu d'entrer dans Configurations. Dans ce cas, répéter l'opération.

### ENTRER DANS CONFIGURATIONS

État : appareil éteint

Appuyer pendant 7 secondes

	Bip
	Clignote
	Fixe

### APPAIRAGE TÉLÉPHONE, GPS, TFT

État : Configurations

Appuyer pendant 3 secondes

	Bip
	Clignote
	Sélectionner BTR1 Adv. sur tél., GPS ou TFT
	Bip
	Validation (1 s)

**Remarque :** pour appairer un 2<sup>e</sup> appareil en son mono, répéter cette procédure en utilisant Vol -.

### APPAIRAGE INTERPHONE MIDLAND

État : Configurations

	Appuyer pendant 3 secondes		Appuyer pendant 3 secondes
	Clignote		Clignote
	Validation (1 s)		Validation (1 s)

Appairage réussi

**Remarque :** pour appairer un autre interphone Midland, suivre la même procédure en utilisant la touche Haut / Bas.

### APPAIRAGE INTERPHONE AUTRE MARQUE (UNIVERSAL INTERCOM)

État : Configurations

Appuyer pendant 7 secondes

	Clignote rapidement (maintenir enfoncé)	Suivre la procédure d'appairage avec le téléphone
	Clignote lentement (relâcher)	

### RÉINITIALISATION DES APPAIRAGES BLUETOOTH

État : Configurations

Appuyer simultanément, 3 secondes

	Bip
	Validation (1 s)
	Fixe

### QUITTER LE MODE CONFIGURATIONS INTERROMPRE L'APPAIRAGE

État : Configurations

Appuyer 2 fois

Le clignotement change

### COUPLAGE AVEC 4 UNITÉS EN CONFÉRENCE

État : Configurations

**Note:** Le mode "Conférence" permet de mettre en communication des personnes simultanément. Pour utiliser la fonction de conférence, les appareils doivent être couplés dans une configuration "en chaîne": associez le bouton "Bas" du premier appareil au bouton "Haut" du deuxième appareil et ainsi de suite. Pour plus d'informations, voir le paragraphe "Conférence" du manuel d'utilisation ou le vidéo tutorial.

Fréquence (GHz)	Puissance de sortie (mW)
2.402 - 2.480	100

Allez sur le site [midlandeurope.com](http://midlandeurope.com), téléchargez le manuel complet et le logiciel BT Updater.

Personnalisez votre interphone et découvrez toutes les fonctions avec **BTPRO SetApp**. Téléchargez-la ici :

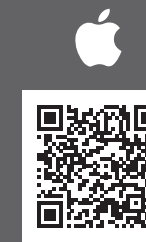

## BTR1 ADVANCED

Bike to Bike Conference Communication



HIGH DEFINITION SOUND BY **RCF**



## MODES DE FONCTIONNEMENT

- A. **Mode Intercom** : pour communiquer avec un autre appareil.
- B. **Mode téléphone** : pour passer des appels ou gérer la musique.
- C. **Mode radio FM** : pour écouter, chercher et mémoriser des stations radio.

**Remarque** : Les modes intercom et téléphone ne sont actifs que lorsqu'il y a des appareils appariés avec les touches Vol+/Vol-.

### SÉLECTIONNER LE MODE DE FONCTIONNEMENT

État : appareil allumé

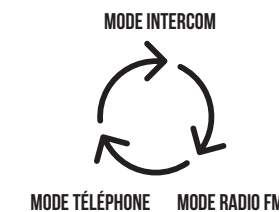

Appuyer pendant 3 secondes pour changer de mode ou maintenir enfoncé pour les faire défiler rapidement

État du mode de fonctionnement

**Remarque** : en appuyant simultanément sur Vol + et Vol - pendant 1 seconde, BTR1 Advanced communique le mode de fonctionnement sélectionné.

### MODE INTERCOM

#### DESCRIPTION DES FONCTIONS

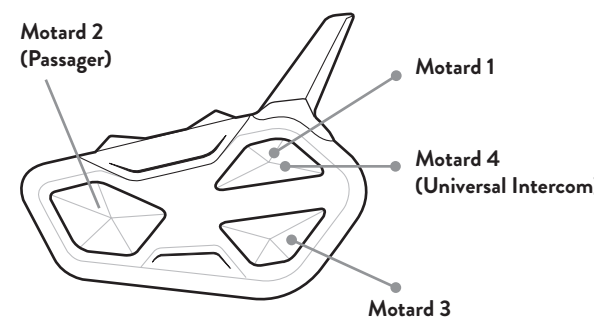

#### OUVRIR/FERMER INTERCOM MANUELLEMENT

État : mode Intercom



**Remarque** : pour communiquer avec le Motard 1/3 répéter l'opération en appuyant sur la touche Haut (motard 1) ou Bas (motard 3).

#### ACTIVER/DÉSACTIVER LE VOX

État : dans tous les modes

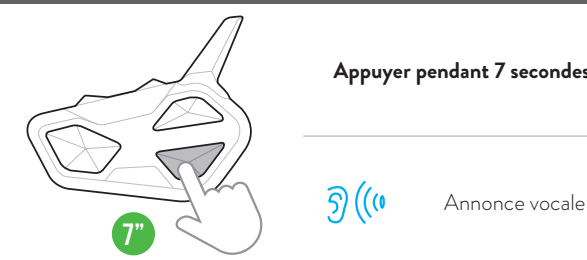

#### OUVRIR/FERMER L'INTERCOM AVEC LA VOIX

État : dans tous les modes

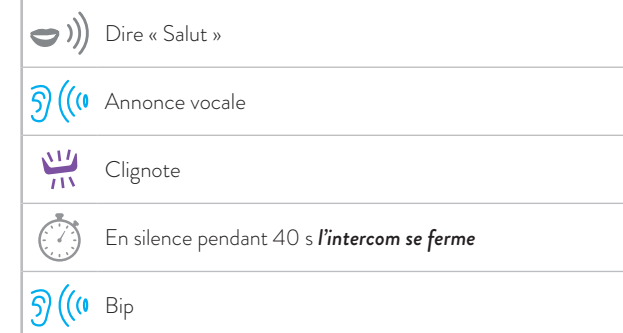

**Remarque** : l'activation vocale n'est possible qu'avec un interphone apparié avec la touche Contrôle.

**RACCOURCI** : En mode Intercom/Radio FM, en appuyant 2 fois sur Contrôle vous activez/désactivez la musique.

#### OUVRIR/FERMER UNIVERSAL INTERCOM

État : mode Intercom

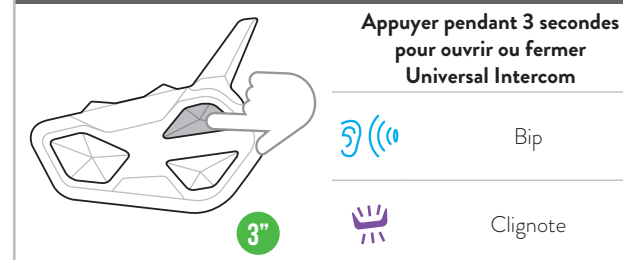

**Remarque** : pour ouvrir/couper le son depuis l'appareil d'une autre marque, utiliser la commande vocale d'appel (pour certains modèles, il faut envoyer l'appel vocal 2 fois).

#### ACTIVER/DÉSACTIVER LE CONFÉRENCE

État : en tous les modes

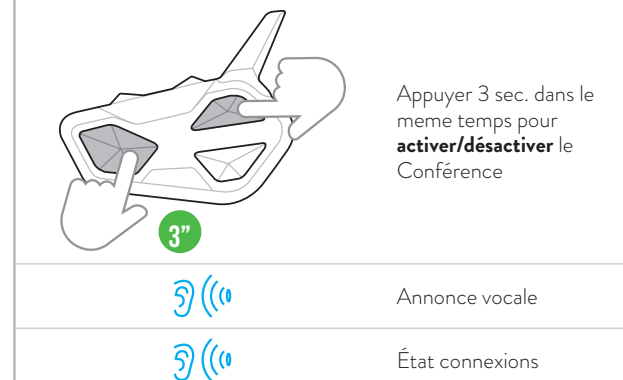

**Note** : en mode Conférence, les unités couplés à Volt+/- sont momentanément déconnectées

#### OUVRIR/FERMER LE CONFÉRENCE

État : Conférence

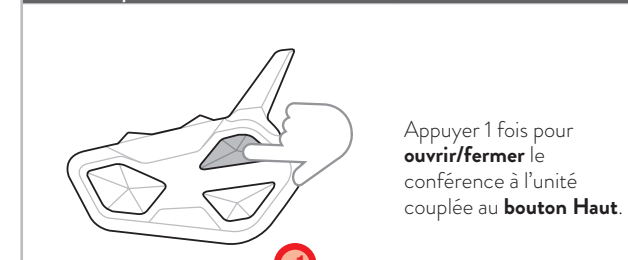

Appuyer 1 fois pour ouvrir/fermer le conférence à l'unité couplée au bouton Haut.

#### OUVRIR/FERMER LE CONFÉRENCE

État : Conférence



Appuyer 1 fois pour ouvrir/fermer le conférence à l'unité couplée au bouton Bas.

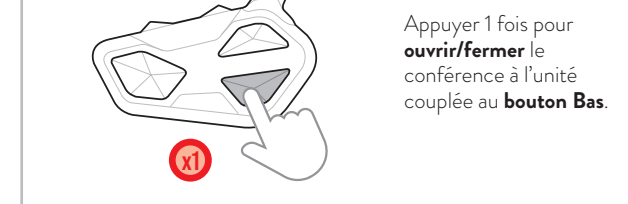

### MODE TÉLÉPHONE

#### DESCRIPTION DES FONCTIONS

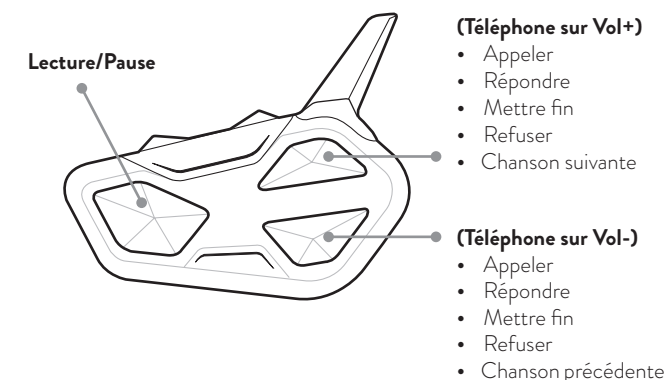

#### PASSER UN APPEL

État : mode Téléphone

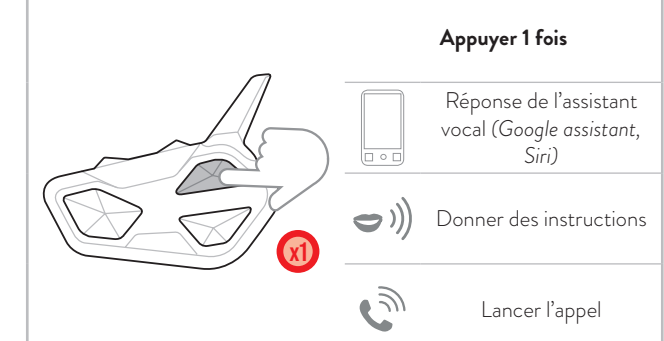

**Remarque** : si vous avez un téléphone apparié avec la touche Vol -, utilisez la touche Bas.

**RACCOURCI** : Dans le mode Téléphone, en appuyant 2 fois sur la touche Up/Down vous ouvrez/fermez l'Intercom (Rider 1, 3).

#### RÉPONDRE/METTRE FIN À UN APPEL REFUSER UN APPEL

État : en tous les modes

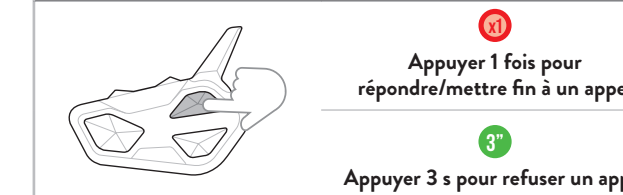

**Remarque** : si vous avez un téléphone apparié avec la touche Vol -, utilisez la touche Bas.

#### MUSIQUE

État : mode Téléphone



### MODE RADIO

#### DESCRIPTION DES FONCTIONS

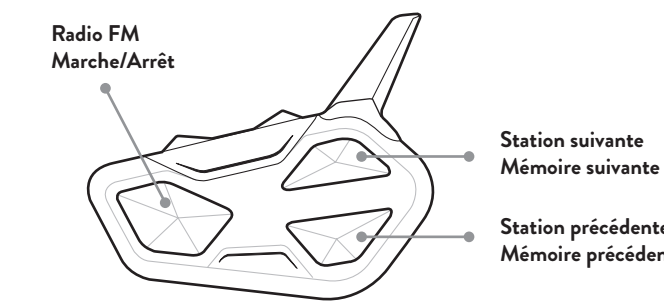

#### RADIO FM

État : mode Radio

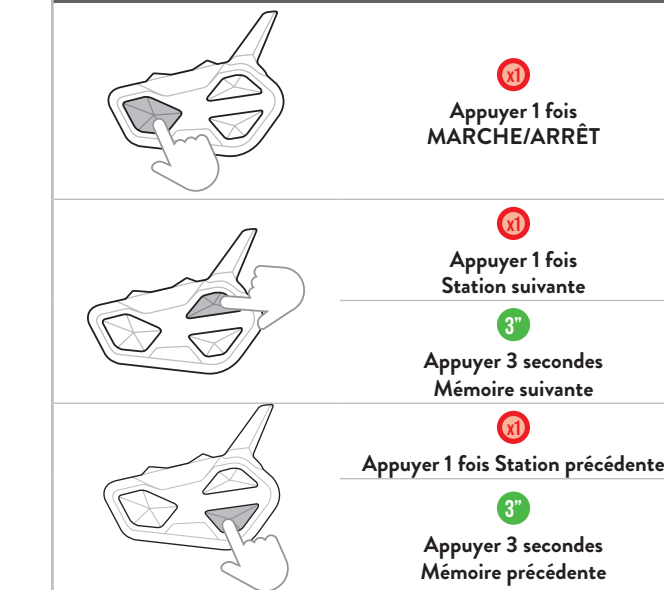

## 开/关

### 按键说明

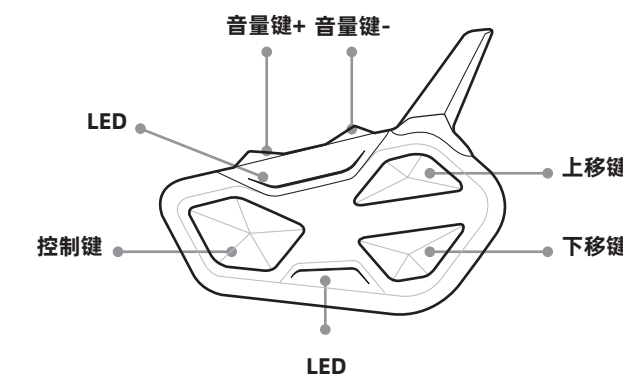

### 开机



### 关机

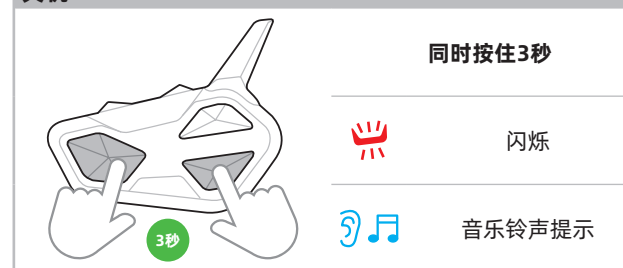

## 配对

### 按键说明

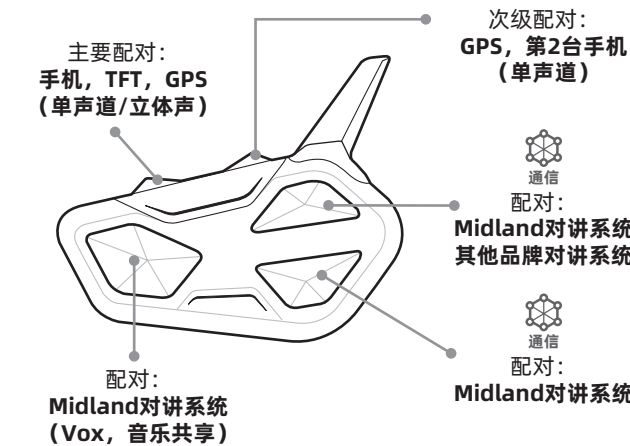

**注意:** 进行任何系统配对前, 必须先进入设置模式。如果按住控制键的时间不到7秒, 设备会启动而不会进入设置模式。如果出现这种情况, 请重新操作。

### 进入设置模式



**说明:** 如需配对第2台单声道设备, 使用音量键-重复上述步骤。

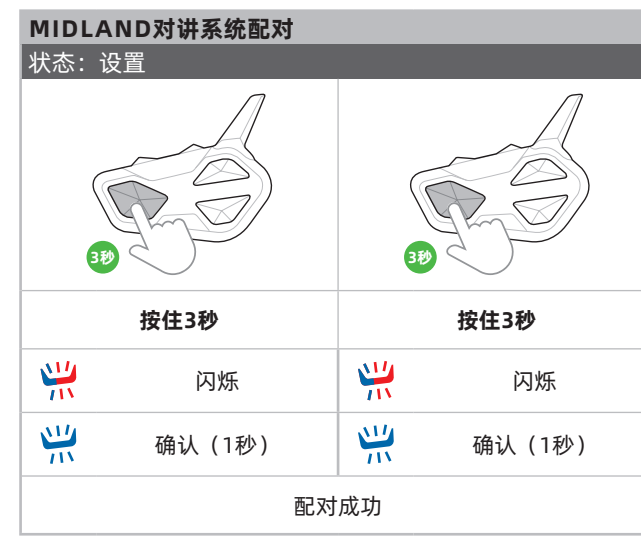

**说明:** 如需配对另一套Midland对讲系统, 使用上移/下移键, 重复上述步骤进行。

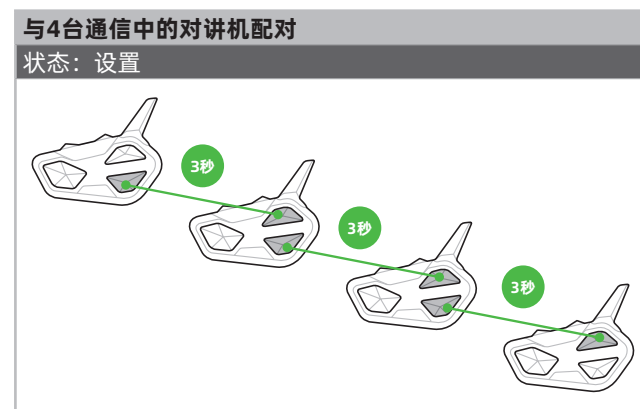

**说明:** 通信模式允许多台设备同时交流。这些设备必须以“链”式配对, 即第一台设备的“下移键”必须与第二台设备的“上移键”配对, 以此类推。如需更多的信息, 请参考用户手册的“通信”部分或教学视频。

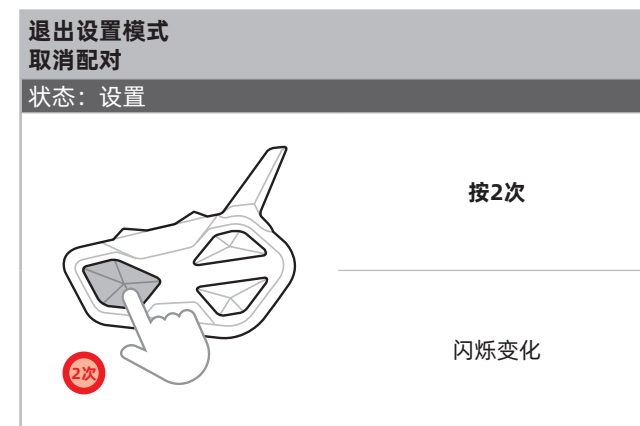

频率 (GHz)	最大功率 (mW)
2.402 - 2.480	100

前往我们的网站 [midlandeurope.com](http://midlandeurope.com), 下载完整的手册和BT Updater升级软件。

用BT PRO SetApp定制您的对讲系统并发现它的所有功能。  
下载地址:

## BTR1 ADVANCED 车对车通信交流系统



高清晰度的声音 RCF



# 运行模式

- A. **对讲模式**: 与其他设备通信。
  - B. **手机模式**: 用于手机通话或管理音乐播放。
  - C. **FM收音机模式**: 用于收听、搜索并存储收音机频道。
- 说明: 对讲模式和手机模式只有在与其他设备配对后才会激活。

## 选择运行模式

状态: 设备启动



按住3秒以改变模式, 或在按住后上下移动进行选择

运行模式状态

说明: 同时按下音量键+和音量键-, BTR1 Advanced将显示所选的运行模式。

## 对讲模式

功能说明

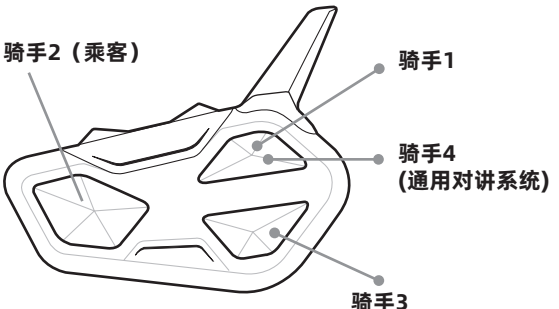

## 对讲系统手动启动/关闭

状态: 对讲模式

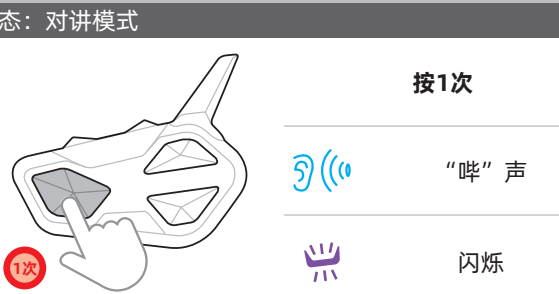

说明: 要与骑手1/3通信, 可重复操作, 按住上移键、(骑手1) / 下移键 (骑手3)。

## VOX激活/停用

状态: 所有模式

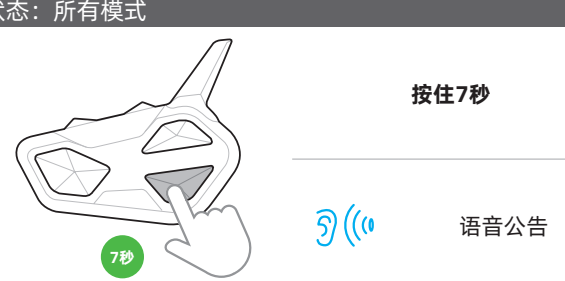

## 对讲系统语音启动/关闭

状态: 所有模式

- 说“Hi”
- 语音公告
- 闪烁
- 如果静音40秒, 对讲系统会关闭
- “哔”声

说明: 只有当一套对讲系统与控制键配对, 才会激活语音助手。

快捷键: 在对讲/FM收音机模式下, 2次按下控制键, 可激活/停用音乐。

## 通用对讲系统启动/关闭

状态: 对讲模式



说明: 如需从其他品牌的设备激活/停用音频, 请使用语音助手激活指令 (对于有些型号需要发送2次激活信号)。

## 通信系统启动/停止

状态: 所有模式



说明: 在通信过程中, 所有与音量键+/-配对的设备会暂时断开。

## 通信系统打开/关闭

状态: 通信



## 手机模式

功能说明

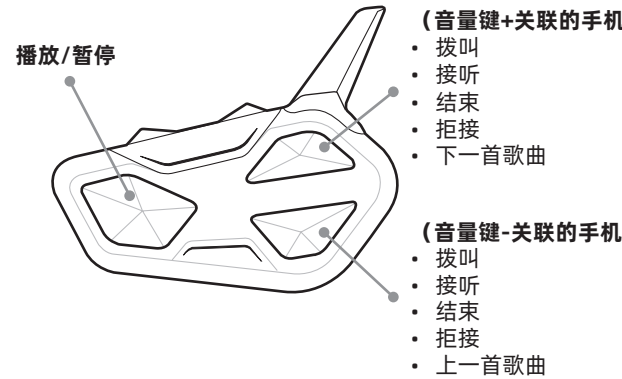

## 语音呼叫

状态: 手机模式



说明: 如果有一台手机与音量键-配对, 请使用下移键。

快捷键: 在听筒模式下, 按2次上/下键即可打开/关闭对讲机系统 (骑手1, 3)。

## 接听/停止通话 拒绝接听

状态: 所有模式



说明: 如果有一台手机与音量键-配对, 请使用下移键。

## 音乐

状态: 手机模式



## 收音机模式

功能说明

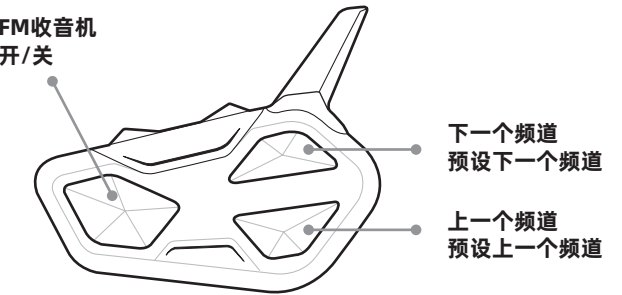

## FM收音机

状态: 收音机模式

